



# AUSTRALIAN MARCO CATALOGUE





# AUSTRALIAN MARCO CATALOGUE INDEX

| <b>CONTENTS</b>                        | <b>PAGE</b> |
|--|-------------|
| <b>1. Marco 8080 Powerfeed Machine</b> | <b>1</b>    |
| 1.1 20mm Cable and Accessories         | 2           |
| 1.2 Cutters and Heads for 20mm Cable   | 3           |
| 1.3 Guide Spoon and Gloves             | 4           |
| 1.4 Electrical Spare Parts             | 5           |
| 1.5 Spare Parts - Marco 8000 Series    | 6-7         |
| 1.6 Dualfeed Unit                      | 8           |
| 1.7 Spare Parts - Dualfeed Unit        | 9           |
| <br>                                   |             |
| <b>2. Auto-Pak 25 (Pick-A-Pack)</b>    | <b>10</b>   |
| 2.1 Spare Parts - Auto-Pak 25          | 11          |
| <br>                                   |             |
| <b>4. Top Snakes</b>                   | <b>12</b>   |
| 4.1 Top Snake Parts and Accesories     | 13          |
| <br>                                   |             |
| <b>5. Extendascope Closet Auger</b>    | <b>14</b>   |
| <br>                                   |             |
| <b>6. Cable Repair</b>                 | <b>15</b>   |
| <br>                                   |             |
| <b>7. Warranty</b>                     | <b>16</b>   |

# 1. MARCO 8080 POWERFEED DRAIN CLEANING MACHINE

Reece Product Code: 7101800

## Standard Equipment Supplied

- 1 - 1/2" HP Australian Electric Motor and Foot Switch.
  - 1 - Dualfeed Unit
  - 1 - #1 Head Set
  - 1 - #46 Tool Box
  - 1 - Operation Manual
- Not included - 15 amp extension lead*

## Contents of #1 Head Set

- 1 - #20 80mm Cutter
- 1 - #21 100mm Cutter
- 1 - #22 150mm Cutter
- 1 - #23 Spear Fin
- 1 - #24 Retriever
- 1 - #25 Auger
- 1 - #307 Root Cutter







| FEATURE                                     | BENEFIT  |
|---|--|
| Drum Machine                                | Minimum handling of cable. "One Man" transport.  |
| 20mm X 23M of Cable in Drum                 | Enough cable to handle most domestic situations.   |
| Drum is very accessible and quick to change | Easy to add another cable and drum for long runs, also cleaning the drum or getting access to the cable necessary.   |
| "Snap-lok" couplings.                       | Cable can be repaired very easily if it breaks. Coupling can be used to repair cable on site in approximately five minutes.  |
| Exclusive Marco Plasticore Cable            | The cable is an oil tempered quality wire coiled cable with a plastic core, which in turn has an inner steel core. The plastic adds to the cable body protection and the steel core adds strength. |
| Dualfeed™                                   | Forward or Reverse at 0-22 feet per minute, can be instantly activated without changing motor direction while cleaning 80mm to 200mm drain and sewer lines.  |
| Australian made motor                       | A 240v motor designed for Australian conditions. Much cheaper to replace, should it be necessary.  |
| Wheel on handle.                            | Easy loading onto vehicles.  |
| Foot switch operation.                      | Easy to control.   |
| Foot switch disconnects                     | The very simple removal of the switch renders the machine impossible to use (useful in situations when there are young children around).   |

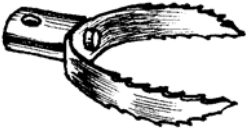
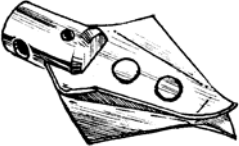

## 1.1. 20mm MACHINES, CABLES AND ACCESSORIES

| PRODUCT CODE | ITEM DESCRIPTION                         |
|--------------|--|
| 7101800      | 8080P POWERFEED DRAIN CLEANING MACHINE   |
| 7101608      | MARCO SEWER CABLE 20MM X 23MTR           |
| 7101634      | MARCO MALE COUPLING #728M 20MM           |
| 7101633      | MARCO FEMALE COUPLING #728F 20MM         |
| 7101635      | MARCO SPLICE COUPLING #728S 20MM         |
| 7101637      | MARCO "T" HANDLE-REPAIR                  |
| 7101610      | MARCO SEWER DRUM ONLY SUIT 8000P #432    |
| 7100373      | MARCO SEWER DRUM & CABLE 23MTR ASSEMBLED |

## 1.2. CUTTERS AND HEADS FOR 20mm CABLE

|  | PRODUCT CODE | ITEM DESCRIPTION                   |       |
|--|--------------|------------------------------------|-------|
|  <p>No. 20, 21 &amp; 22 Cutters are general-purpose cutters designed for light root cutting and descaling pipe.</p>                 | 7101591      | MARCO SEWER ROD CUTTER #20         | 80MM  |
|  | 7101593      | MARCO SEWER ROD CUTTER #21         | 100MM |
|  | 7101595      | MARCO SEWER ROD CUTTER #22         | 150MM |
|  <p>No. 23 Spear Fin Head is designed to break up grease and hard material.</p>   | 7101597      | MARCO SEWER ROD SPEAR FIN HEAD #23 |       |
|  <p>No. 24 New Style Retriever Head is designed for removal of rags, mopheads, and also for retrieving broken cables.</p>           | 7101599      | MARCO SEWER ROD RETRIEVER HEAD #24 |       |
|  <p>No. 25 Auger Head is designed for clearing drains blocked with silt and fatty substances.</p>                                 | 7101602      | MARCO SEWER ROD AUGER HEAD #25     |       |
|  <p>No. 307 Root cutter is designed for clearing blockages by cutting and tearing through blockages with a sharp edged blade.</p> | 7101603      | MARCO SEWER ROD ROOT CUTTER #307   |       |
|  <p>No. 312 100mm Trap Leader is designed for clearing obstructions in gully traps. Supplied with a 80mm cutter</p>               | 7101605      | MARCO SEWER ROD TRAP LEADER        |       |

## 1.3 GUIDE SPOON AND GLOVES



No. 808 Guide Spoon used for guiding Marco cable down sewer fittings such as Government I.P Boundary Traps etc.

| <u>PRODUCT CODE</u> | <u>ITEM DESCRIPTION</u> |
|---------------------|-------------------------|
|---------------------|-------------------------|

---

7101640

MARCO GUIDE SPOON #808

---



Heavy Duty Drain Cleaning Gloves. Coated with PVC for extra protection from cable and material retrieved from blocked drains.

7101700

DRAIN CLEANING GLOVES H/DUTY

---

## 1.4. ELECTRICAL SPARE PARTS

| PRODUCT CODE | ITEM DESCRIPTION |
|--------------|------------------|
|--------------|------------------|

### ELECTRIC MOTOR

|         |   |
|---------|---|
| 7101627 | MARCO FWD/REV SWITCH COMP (GMG) #718 <b>OLD STYLE</b> |
| 7101704 | MARCO FWD/REV SWITCH COMP (CMG) #718 <b>NEW STYLE</b> |
| 7101724 | MARCO BASE FOR FWD/REV SWITCH (CMG)                   |
| 7101630 | MARCO FOOTSWITCH #719 WITH CABLE                      |
| 7100364 | MARCO CABLE GLAND (AUST) NG14                         |

### C M G MOTOR (Silver Colour) SPARE PARTS (Current Model)

|         |  |
|---------|--|
| 7101646 | MARCO FAN COWL CMG10 5448              |
| 7101647 | MARCO FAN CMG11 5092                   |
| 7101648 | MARCO CAPACITATOR COVER BASE CMG       |
| 7101649 | MARCO CAPACITATOR COVER CMG            |
| 7100365 | MARCO CAPACITOR C M G #160-192MFD 165V |

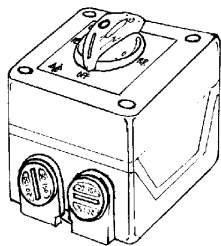

For/Rev Complete Switch

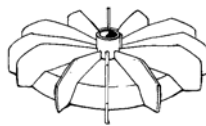

Typical Fan

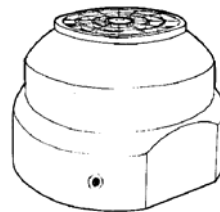

Typical Fan Cowl

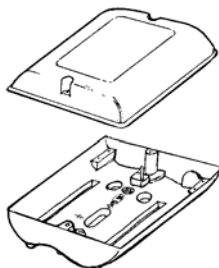

Typical Capacitor Cover

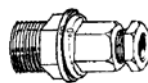

Cable Gland

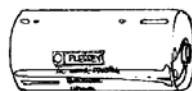

Typical Capacitor

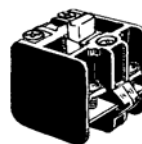

Contact Block

## 1.5. SPARE PARTS - MARCO 8000 SERIES POWERFEED

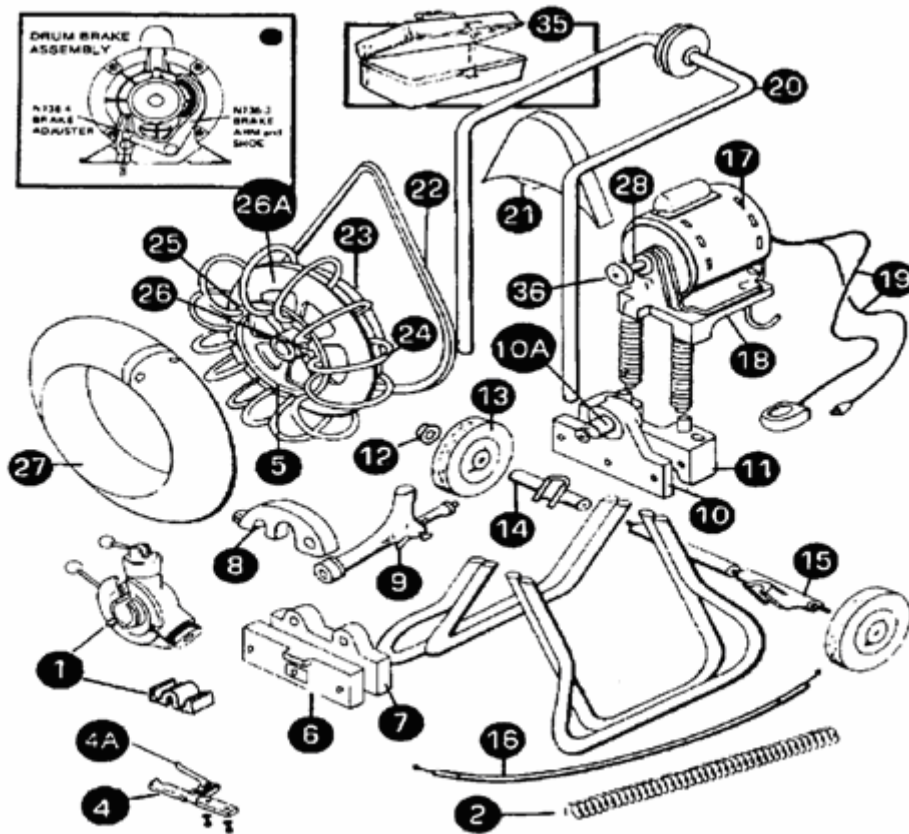

**FIGURE 1**

| KEY# | PRODUCT CODE | ITEM DESCRIPTION   |
|------|--------------|--|
| 1    | 7101781      | MARCO DUAL FEED UNIT # 6588NEW STYLE <u>EXCLUDING GUIDE SPRING</u> |
|      | 7101785      | MARCO DUAL FEED UNIT W/GUIDE SPRING #6588 <b>NEW STYLE</b>         |
| 2    | 7101638      | MARCO DUALFEED GUIDE SPRING 750 <u>ONLY</u> 8337                   |
| 4    | 7101668      | MARCO BRAKE LEVER N736-2A  |
| 5    | 7100354      | MARCO DRUM LEADER 5FT (AUST) N727-5                                |
| 6    | 7100355      | **MARCO FEED MOUNT N702R ( can be ordered on request )             |
| 7    | 7100356      | MARCO FRONT BEARING MOUNT N729                                     |
| 8    | 7101664      | MARCO SWING BEARING N707   |
|      | 7101665      | MARCO SWING BEARING TENSION SPRING N707A                           |
| 9    | 7101655      | MARCO TORQUE TUBE N37 9774   |
|      | 7101656      | MARCO BRONZE BEARING TORQUE TUBE N37A <b>NEW STYLE</b>             |
|      | 7101657      | MARCO BRONZE BEARING TORQUE TUBE N37AOS <b>OLD STYLE</b>           |
|      | 7101658      | MARCO RETAINING CLIP BRONZE BEARING N37B <b>NEW STYLE</b>          |
|      | 7101659      | MARCO RETAINING CLIP BRONZE BEARG N37BOS <b>OLD STYLE</b>          |
| 10   | 7101703      | MARCO REAR BEARING MOUNT ONLY N731                                 |

## 1.5. SPARE PARTS - MARCO 8000 SERIES POWERFEED

(Refer Figure 1)

| KEY# | PRODUCT CODE | ITEM DESCRIPTION   |
|------|--------------|--|
| 10A  | 7101624      | MARCO SPINDLE BEARING #711A  |
| 10A  | 7101625      | MARCO DRUM SPINDLE & NUT FOR PF80                                    |
| 11   | 7101660      | MARCO REAR HANDLE MOUNT N703   |
|      | 7101662      | MARCO AXLE ROD N705A   |
|      | 7101623      | MARCO SLEEVE SUIT 200MM WHEEL #706-8C ( can be ordered on request )  |
| 13   | 7101622      | MARCO WHEEL SEMI-PNEUMATIC 200MM #8999                               |
| 13A  | 7101663      | MARCO WHEEL LOADING 150MM N706-6                                     |
| 14   | 7101661      | MARCO AXLE MOUNT RIGHT N704  |
| 15   | 7101667      | MARCO AXLE MOUNT LEFT N730   |
| 16   | 7101669      | MARCO CABLE DRUM BRAKE N736-5  |
| 17   | 7101701      | MARCO ELECTRIC MOTOR .5HP LESS FT/SWITCH                             |
| 18   | 7100357      | MARCO MOTOR MOUNT COMPLETE 9111/N716                                 |
| 20   | 7101626      | MARCO HANDLE COMPLETE WITH WHEEL #712                                |
| 21   | 7100358      | MARCO PULLEY GUARD 8700/P120   |
| 22   | 7101654      | MARCO VEE BELT A47 / N36   |
| 23   | 7101666      | **MARCO BACK DRUM CASTING SET N713 ( can be ordered on request )     |
| 24   | 7100359      | **MARCO DRUM RING 8788/N715 ( can be ordered on request )            |
| 26   | 7101615      | MARCO LOCK PIN SUIT 8000 MACHINE #9277                               |
| 27   | 7100360      | MARCO SPLASH COVER 8699/119  |
| 28   | 7100361      | **MARCO DRUM BRAKE ASSEMBLY N736 ( can be ordered on request )       |
|      | 7100362      | **MARCO BRAKE ARM AND SHOE 9211/N736-3 ( can be ordered on request ) |
| 35   | 7101588      | MARCO TOOL BOX (PF8080) COMPLETE W/HEAD SET                          |
|      | 7101589      | MARCO DRAIN CLEANING MACHINE TOOL BOX ONLY                           |
| 36   | 7101670      | MARCO SMALL PULLEY N737  |
|      | 7100363      | MARCO LARGE PULLEY (BRAKE DRUM) N737B                                |

## 1.6. DUALFEED UNIT

- Suitable for 8000 Series Powerfeed Machines.
  - Old MARCO machines with PF80R Front End can be fitted with the NEW Dualfeed Unit.

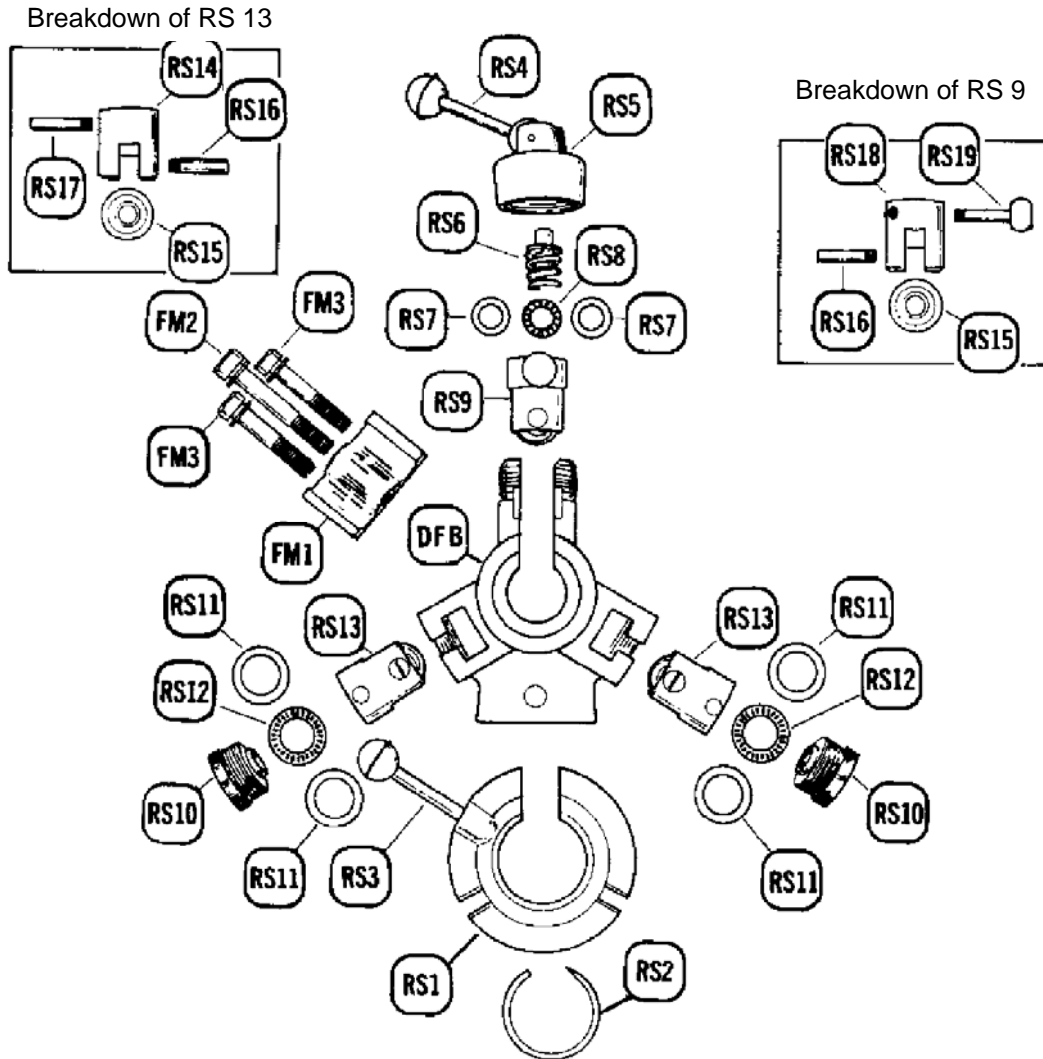

FIGURE 2

| PRODUCT CODE | ITEM DESCRIPTION   |
|--------------|--|
| 7101781      | MARCO DUAL FEED UNIT # 6588NEW STYLE <u>EXCLUDING GUIDE SPRING</u> |

| KEY# | PRODUCT CODE | ITEM DESCRIPTION  |
|------|--------------|---|
| DFBN | 7101782      | MARCO DUAL FEED BODY CASTING <b>NEW STYLE</b> , if you are replacing an old style casting you must replace the top bearing holder with a new style one ( RS18 ). Code 7101784. The old one will not fit the new one |
| RS1  | 7101671      | MARCO DUAL FEED CAM PLATE RS1 <b>OLD STYLE</b>  |
| RS1  | 7101688      | MARCO DUAL FEED CAM PLATE RS1 <b>NEW STYLE</b>  |

## 1.7. SPARE PARTS - DUALFEED UNIT

Refer Figure 2

| KEY#  | PRODUCT CODE | ITEM DESCRIPTION  |
|-------|--------------|---|
| RS2   | 7101681      | MARCO DUAL FEED CAM PLATE LOCK RING RS2                                       |
| RS3   | 7101682      | MARCO DUAL FEED CAM PLATE HANDLE RS3  |
| RS4   | 7101683      | MARCO DUAL FEED TOP CAP CAM HANDLE RS4  |
| RS5   | 7101684      | MARCO DUAL FEED TOP ADJUSTING CAP RS5   |
| RS6   | 7101685      | MARCO D/FEED SPRING & CAM PLUNGER RS6   |
| RS7   | 7101686      | MARCO DUAL FEED WASHER TOP BEARING RS7  |
| RS8   | 7101687      | MARCO DUAL FEED BEARING TOP BEARING RS8                                       |
| RS9   | 7100352      | MARCO D/FEED TOP BEARING HOLDER COMP <b>OLD</b>                               |
| RS9   | 7101784      | MARCO D/FEED TOP BEARING HOLDER ONLY <b>NEW</b>                               |
| RS9N  | 7101783      | MARCO D/FEED TOP BEARING HOLDER COMP <b>NEW</b>                               |
| RS10  | 7101672      | MARCO D/FEED BOTTOM ADJUST CAP BOLT RS10                                      |
| RS11  | 7101673      | MARCO D/FEED WASHER BOTTOM BEARING RS11                                       |
| RS12  | 7101674      | MARCO DUAL FEED BOTTOM BEARING(FLAT)RS12                                      |
| RS13  | 7100353      | MARCO BOTTOM BEARING RS13   |
| RS14  | 7101675      | **RCO D/FEED BOTTOM BEARING HOLDER RS14 ( can be ordered on request )         |
| RS15  | 7101676      | MARCO DUAL FEED SMOOTH FORM ROLLER RS15                                       |
| RS16  | 7101677      | MARCO D/FEED AXLE SUIT RS15 BEARING RS16                                      |
| RS17  | 7101678      | MARCO D/FEED BOTTOM HOLDER CAM PIN RS17                                       |
| RS18  | 7101679      | **RCO D/FEED TOP BEARING HOLDER RS18 <b>OLD</b> ( can be ordered on request ) |
| RS18N | 7101784      | MARCO D/FEED TOP BEARING HOLDER ONLY <b>NEW</b>                               |
| RS19  | 7101680      | MARCO D/FEED TOPHOLDER CAM KNOB PIN RS19                                      |
| FM1   | 7101652      | **MARCO DUAL FEED MOUNTING BLOCK 9820 ( can be ordered on request )           |
| FM2   | 7101653      | MARCO DUAL FEED MOUNTING BLOCK BOLT 9821                                      |

## 2. AUTOPAK 25 (PICK-A-PAK)

### AutoPak

Features:



For clearing drains 40mm to 80mm in diameter

Safety-proven double insulated, shock-proof, heavy duty motor with variable speed control

"Mini-Feed" for fully automatic 0 to 22 feet per minute feed and retrieval

Supplied with 10mm x 7.5m Plasticore cable, Open Cutter, Drop Head and Bore Head all in a sturdy metal carry case

#### **PRODUCT CODE ITEM DESCRIPTION**



7100435 MARCO AUTOPAK 25 C38 X 7.5MTR COMPLETE

#### **SPARE PARTS AND ACCESSORIES FOR AUTOPAK 25**



7100423 MARCO SNAPLOCK BORE HEAD AUTOPAK 25 10MM



7100424 MARCO SNAPLOCK DROP HEAD AUTOPAK 25 10MM



7100425 MARCO SNAPLOCK OPEN CUTTER AUTOPK25 10MM



7100408 MARCO CABLE MALE COUPLING C38 10MM



7100407 MARCO CABLE FEMALE COUPLING C38



7100405 MARCO CABLE A/PAK25 & T/SNAKE C10MM X 7.5M

NEW STYLE FEED SYSTEM (Released June 95)

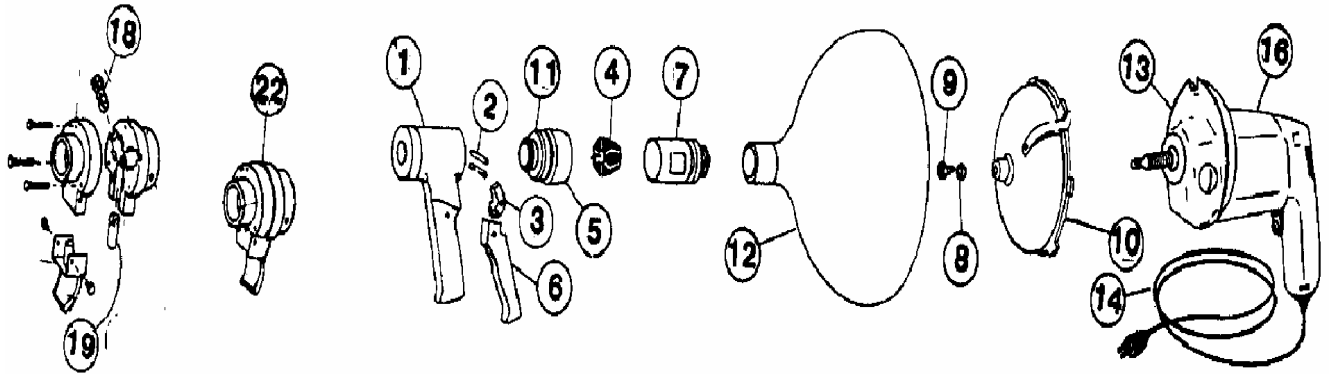

Figure 3

**KEY#      PRODUCT CODE    ITEM DESCRIPTION**

(Refer Figure 3 above)

|    |         |  |
|----|---------|--|
| 1  | 7101780 | **RCO S-1 AUTOPAK CHUCK BODY (NEW STYLE) ( can be ordered on request ) |
| 2  | 7100432 | **ARCO AUTOPAK S-4 ADJUSTING SCREW #5333 ( can be ordered on request ) |
| 3  | 7100433 | **ARCO AUTOPAK S-5 ADJUSTING SCREW #5344 ( can be ordered on request ) |
| 4  | 7100366 | MARCO RUBBER COLLETT S288/S6   |
| 5  | 7100452 | MARCO SC SPINDLE CAP ASSY WITH S6 COLLET                               |
| 6  | 7101712 | GRIPPING LEVER S-12 MARCO 5411   |
| 7  | 7101730 | MARCO SQUEEZE SPINDLE ASSY & COLLET                                    |
| 10 | 7101734 | MARCO FLANGE ADAPTOR S-16 # 5455                                       |
|    | 7101732 | MARCO H500H FLANGE ADAPTOR #1344 <b>OLD STYLE</b>                      |
| 11 | 7100434 | MARCO AUTOPAK S-17 BALL BEARING SET (17)                               |
| 12 | 7100367 | MARCO DRUM ONLY SUIT PICKAPACK 5166/MP38                               |
| 16 | 7100436 | MARCO AUTOPAK DRILL ONLY #9781   |
| 18 | 7100368 | MARCO TOP MINI FEED ROLL <b>OLD STYLE</b>                              |
|    | 7100375 | MARCO TOP MINI FEED ROLL <b>NEW STYLE</b>                              |
| 19 | 7100369 | MARCO BOTTOM MINI FEED ROLL #5953 <b>OLD STYLE</b>                     |
|    | 7100376 | MARCO BOTTOM MINI FEED ROLLER <b>NEW STYLE</b>                         |
| 22 | 7100370 | MARCO PICKAPACK MINI FEED COMP W/3 SCREW                               |

## 4. TOP SNAKES

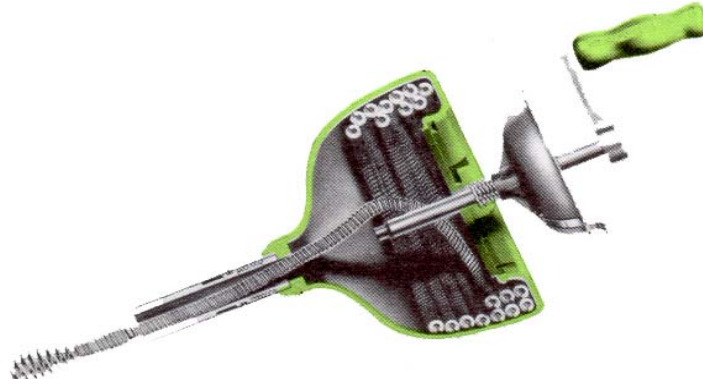

The TOP SNAKES with a 6mm bore head is for use in 40mm to 50mm basin and sink wastes and is available in a 7.5m Plasticore cable length.

- The TOP SNAKES with a 10mm bore head or 10mm "snaplok" head, are for use in 40mm to 65mm waste pipes & Drains, and is available in a 7.5m length of Plasticore cable.
- All TOP SNAKES have the offset handle for revolving balance. The handle casting is quickly removed for inspection & maintenance. Positive lock on spring when turning handle to right – revolve handle to left to release spring.

### **PRODUCT CODE    ITEM DESCRIPTION**

---

#### **ECONOMY TOP SNAKE**

7100413                    MARCO ECONOMY TOP SNAKE 1055 6MM

#### **TOP SNAKES COMPLETE WITH BORE HEAD**

7100410                    MARCO TOP SNAKE DRAIN CLEANER 6MM X 7.5M

#### **TOP SNAKE COMPLETE WITH "SNAPLOK" INTERCHANGEABLE HEADS**

7100442                    MARCO TOP SNAKE W/HEAD SET 10MM X 7.5MTR

#### **TOP SNAKES SPARE PARTS AND ACCESSORIES CABLES**









7100401                    MARCO CABLE SUIT TOP SNAKE **B**6MM X 4.5MTR

7100402                    MARCO CABLE SUIT TOP SNAKE **B**6MM X 7.5MTR

7100405                    MARCO CABLE A/PAK25 & T/SNAKE **C**10MM X 7.5M

Note. **B** stands for **BORE HEAD** and **C** stands for **SNAP LOK HEADS**

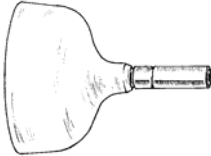
## 4.1. TOP SNAKE SPARE PARTS AND ACCESSORIES - MARCO

|   | <b>PRODUCT</b> | <b>DESCRIPTION</b>  |
|---|----------------|---|
|   | 7100421        | MARCO SCREW ON BORE HEAD MARCO 6MM                                    |
|    | 7100422        | MARCO SCREW ON BORE HEAD 10MM   |
|    | 7100423        | MARCO SNAPLOCK BORE HEAD 10MM   |
|    | 7100425        | MARCO SNAPLOCK OPEN CUTTER 10MM                                       |
|    | 7100424        | MARCO SNAPLOCK DROP HEAD 10MM   |
|   | 7100408        | MARCO CABLE MALE COUPLING C38 10MM                                    |
|  | 7100407        | MARCO CABLE FEMALE COUPLING C38 10MM                                  |
|   | 7100417        | MARCO TOP SNAKE DRUM HANDLE&CASTING HC25                              |
|  | 7100371        | MARCO TOP SNAKE DRUM ONLY MP2500/MPD25                                |
|  | 7100416        | **MARCO TOP SNAKE HANDLE CASTING MPC<br>( can be ordered on request ) |
|  | 7100418        | MARCO TOP SNAKE HANDLE ONLY MPH                                       |
|   | 7101732        | MARCO H500H FLANGE ADAPTOR #1344 <b>OLD STYLE</b>                     |

## 5. EXTENDASCOPE CLOSET AUGER



- Designed for use in clearing toilet pan blockages but can also be used with urinal blockages and in some instances shower risers.
- Cable on the Closet Auger extends from 900mm to 1800mm when depressing male coupling button on handle.
- Extra cable can be added on end of Closet Auger cable to clear that extra length of drain.
- The 1200mm extensions are economical, easily stored and transported and are quickly assembled with Marco "Snap-lok".

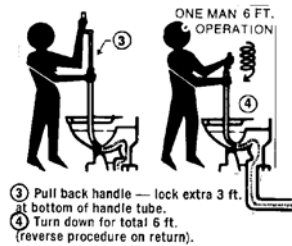

| PRODUCT CODE | ITEM DESCRIPTION |
|--------------|------------------|
|--------------|------------------|



7100349

CLOSET AUGER WHE3-6 MARCO 1116

### CLOSET AUGER SPARE PARTS AND ACCESSORIES



7100409

MARCO CABLE CRAWL HEAD C38 10MM



7100411

MARCO CABLE DROP HEAD C38 #1255 10MM



7100412

MARCO CABLE MALE COUPLING CL28M #1277

7100348

MARCO CLOSET AUGER EXT CABLE REFILL 1.2M

7101774

MARCO WHE 150MM LEADER SPRING ONLY #1124

## 6. CABLE REPAIR

A very common cause of broken cables as previously stated, is fatigue caused by overheating. This problem can be minimised and the life of the cable extended, by making sure your machine is always kept in good condition and operated in a proper manner.

Please note that any chemicals put into drains whether caustic or acidic, can have a detrimental effect on the cables. This is called hydrogen embrittlement and it will occur within minutes of contact. Always neutralise or remove from the drain before using your Marco machine.

There are two approved methods of repair. The most common, and easier method is to use a 728F ¾" and a 728M ¾" Male Snaplock coupling on the each end, and then push the two couplings together. The other method is to use a 728S ¾" Splice Coupling. This makes a more compact repair, but the coupling is more difficult to fit.

### REPAIR

The following is the suggested method of repair using the two Snaplock Couplings.

1. Cut off approximately 150mm of cable from the break. This will generally remove most of the fatigued cable. Care must be taken when cutting to ensure the cable does not overheat.
2. Grind the cut end of the cable with either a bench or angle grinder, so that the end is flat and at right angles to the cable (Fig 1.) Grinding off the end will allow the coupling to seat down properly against the cable, and will minimise the chance of snapping the coupling when fitting. As before, care must be taken to ensure the cable does not overheat whilst grinding. Remove any metal burr from the cable end with a file.
3. Clamp the cable securely in a vice, leaving about 20-25mm protruding above the vice (Fig 3). Drill out the centre of the plasticore and wire to the depth of about 25mm using a **19/64" Drill bit**.
4. Place either a male or female coupling into the TH728R Coupling Tool (Fig 3). Put a small amount of grease on the coupling thread and while maintaining a downward pressure between the coupling thread and the cable end, rotate the handle in a clockwise direction until the coupling is fully inserted into the cable end.
5. Repeat with the other cable end and coupling. If you have difficulty when starting to screw in the coupling, insert a screwdriver blade under the first coil and lift this section slightly while making the first insertion.
6. To test that the coupling is correctly fitted, attach the TH728R Coupling Tool to the coupling and apply mild pressure in an anti clockwise direction. The coupling should not unscrew.

The TH728R Coupling Tool has been developed by staff who has fitted countless couplings and is available at your nearest Reece Plumbing Centre.

Grind the cut end of the cable

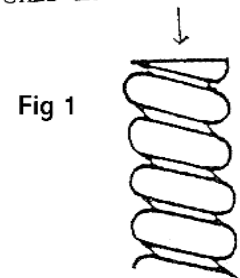

Fig 1

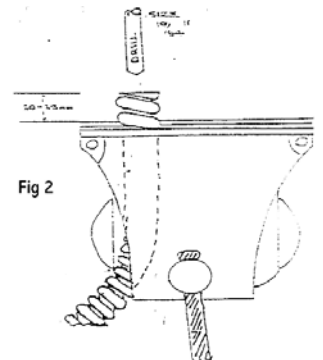

Fig 2

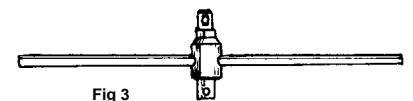

Fig 3

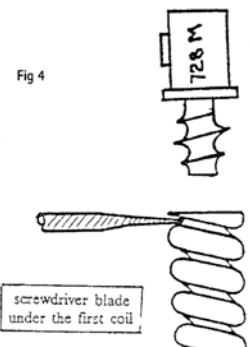

Fig 4

screwdriver blade  
under the first coil

# Warranty

Marco Drain Cleaners are covered for 12 months against the defects of manufacture and poor workmanship, exclusive of fair wear and tear.

Damage caused by accidental or improper use is not covered.

Expendable materials, such as cables and cutting heads are not covered due to the variation in Drain and Blockage conditions.